

# BIOCLIP mechanical basin mixer

Ref. 2820T

Single hole removable mechanical mixer H.95mm L.120mm, solid lever

2026 UK public price excluding VAT: £386.49







## DESCRIPTION

**BIOCLIP mechanical basin mixer - Ref. 2820T**

Deck-mounted mechanical basin mixer.  
 BIOCLIP mechanical mixer: mixer can be removed entirely for cleaning and disinfection.  
 Single hole mixer with spout H. 95mm, L. 120mm fitted with a BIOSAFE hygienic flow straightener.  
 Spout suitable for fitting a BIOFIL point-of-use filter.  
 Ø 35mm ceramic cartridge with pre-set maximum temperature limiter.  
 Thermal shocks are easy to undertake without removing the control lever or shutting off the water supply.  
 Body and spout with smooth interiors and low water volume.  
 No risk of cross flow between the hot and cold water.  
 No non-return valves on the inlets.  
 Flow rate regulated at 5 lpm.  
 Solid control lever.  
 1 1/4" ergonomic, brass pop-up waste.  
 PEX flexibles F3/8" supplied with stopcocks in chrome-plated brass.  
 Fixing reinforced by 2 stainless steel rods.  
 Mechanical mixer ideal for healthcare facilities, retirement and care homes, hospitals and clinics.  
 Single hole mixer suitable for people with reduced mobility.  
 Mixer with 30-year warranty.  
 Also available with copper tails

## ADVANTAGES





-  Hygiene: remove for internal cleaning
-  Hygiene: smooth interior reduces bacteria
-  Pre-set maximum temperature limiter
-  Ergonomic: solid lever is easy to grip

## TECHNICAL CHARACTERISTICS

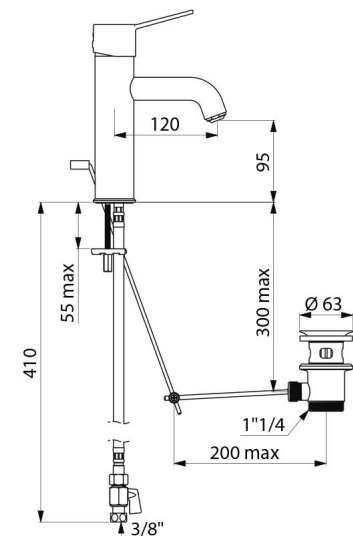
**BIOCLIP mechanical basin mixer - Ref. 2820T**

Connector	F3/8"
Technology	BIOCLIP removable mixer
Drop height	95mm
Spout length	120mm
Flow rate	5 lpm
Temperature limiter	Yes
Finish	Chrome-plated brass



Norms	   
Warranty	

---

Repairability

