

# Angled, two-wall shower grab bar, white anti-bacterial Nylon

Ref. 5100N

Bright white NylonClean anti-bacterial HR Nylon

2026 UK public price excluding VAT: £343.86

## DESCRIPTION

**Angled, two-wall shower grab bar, white anti-bacterial Nylon - Ref. 5100N**

Angled, two-wall grab bar with vertical bar for people with reduced mobility, Ø 32mm.

Can be used as a support bar and to support the user in an upright position. Helps and secures movement in the shower.

Can be used as a shower bar by adding a sliding shower head holder and/or soap dish.

NylonClean anti-bacterial treatment: optimal protection against bacterial development.

Can be installed with the upright to the left or right side.

Suitable for intensive use in public places or the healthcare sector.

High strength polyamide (Nylon): with 2mm reinforced steel core treated against corrosion.

Uniform non-porous surface for easy maintenance and hygiene.

Good resistance to chemical products and cleaning. Anti-UV treatment.

Warm to the touch.

38mm gap between the bar and the wall: minimal space prevents the forearm passing between the bar and the wall, reducing the risk of fracture in case of loss of balance.

Concealed fixings, secured to wall by a 6-hole plate, Ø 73mm.

Supplied with stainless steel screws for concrete walls.

Dimensions: 1,245 x 570 x 660mm.

Tested to over 200kg. Maximum recommended user weight 135kg.

30-year warranty. CE marked.

## TECHNICAL CHARACTERISTICS

**Angled, two-wall shower grab bar, white anti-bacterial Nylon - Ref. 5100N**

Height	1,245mm
Length	570mm
Width	660mm
Diameter	Ø 32mm
Width to the wall	38mm
Thickness	Nylon: 3.5mm; Steel: 2mm
Finish	Btight white anti-bacterial HR Nylon

Norms

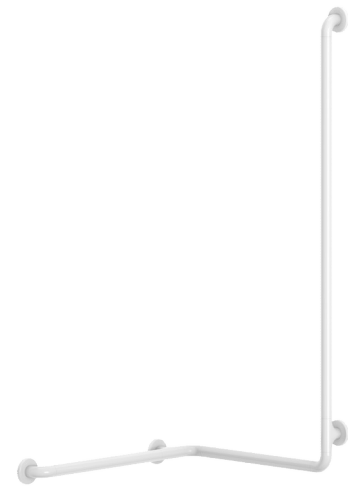

## ADVANTAGES



NylonClean anti-bacterial treatment



Tested to over 200kg



Gap between wall and bar 38mm: minimal space



Withstands chemical products and cleaning

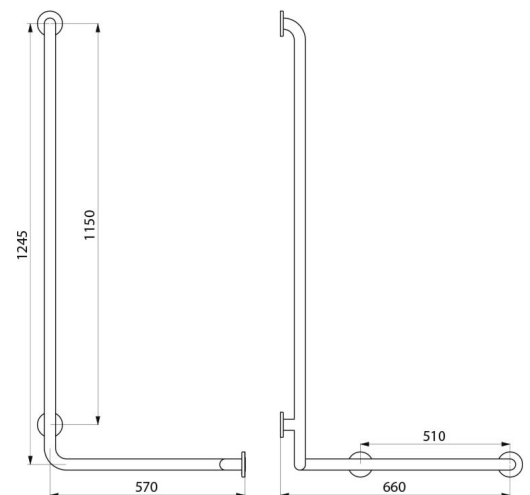

---

Warranty

