

# Mechanical basin mixer swivelling spout H.200 L.170

Ref. 2564T5

Single hole, single control tall mixer with ceramic cartridge

## DESCRIPTION







**Mechanical basin mixer swivelling spout H.200 L.170 - Ref. 2564T5**

Deck-mounted mechanical basin mixer  
Single hole, single control with swivelling spout H. 200mm L. 170mm.  
Tall mixer with BIOSAFE hygienic outlet suitable for fitting a BIOFIL point-of-use filter.  
Ø 35mm classic ceramic cartridge with pre-set maximum temperature limiter.  
Body and spout with smooth interiors (reduces bacterial development).  
No risk of cross flow between the hot and cold water.  
No non-return valves on the inlets.  
Thermal shocks are possible without removing the control lever or shutting off the cold water.  
Flow rate regulated at 5 lpm.  
Chrome-plated brass body and base.  
Hygiene control lever L. 185mm requires no manual contact.  
PEX flexibles F3/8".  
Fixings reinforced via 2 stainless steel rods.  
Mechanical mixer ideal for healthcare facilities, retirement and care homes, hospitals and clinics.  
Single hole mixer suitable for people with reduced mobility.  
Mixer with 30-year warranty.

## TECHNICAL CHARACTERISTICS

**Mechanical basin mixer swivelling spout H.200 L.170 - Ref. 2564T5**

Connector	F3/8"
Height	362mm
Drop height	200mm
Spout length	170mm
Flow rate	5 lpm
Temperature limiter	Yes
Finish	Chrome-plated brass

Norms	   
	
Warranty	



## ADVANTAGES



Hygiene: smooth interior reduces bacteria



Thermal shocks are possible without removing lever



Pre-set maximum temperature limiter



Hygiene lever for no manual contact

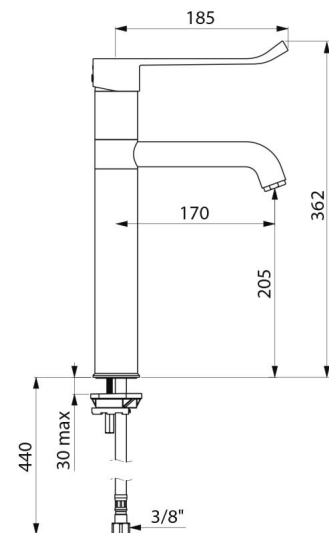

---

Repairability

