

# Aluminium shower panel with SECURITHERM sequential mixer

Ref. H9635

Sequential thermostatic





## DESCRIPTION

Aluminium shower panel with SECURITHERM sequential mixer - Ref. H9635

Anodised aluminium shower panel for wall-mounted, exposed installation: SECURITHERM sequential thermostatic mixer (non time flow). Adjustable temperature control from cold water up to 39°C; maximum temperature limiter set at 39°C, can be adjusted. Anti-scalding failsafe: automatic shut-off if cold water fails. Anti-cold showers function: automatic shut-off if hot water fails. Thermal shocks are possible. Flow rate 9 lpm at 3 bar. Sliding handset on a chrome-plated riser rail with removable flexible hose via rapid push-fit STOP connector. Hygiene control lever L. 100mm. Concealed supply via M1/2" flexibles. Concealed fixings. Filters. Suitable for people with reduced mobility. 30-year warranty.





## TECHNICAL CHARACTERISTICS

Aluminium shower panel with SECURITHERM sequential mixer - Ref. H9635

Supply	Concealed, via M1/2" flexible
Connector	M1/2"
Technology	Sequential thermostatic SECURITHERM
Height	1045mm
Width	210mm
Flow rate	9 lpm
Temperature limiter	39°C
Finish	Aluminium
Norms	  
Warranty	



## ADVANTAGES

-  Sequential: opens/closes with cold water
-  No non-return valves on inlets
-  SECURITHERM: optimal anti-scalding safety
-  Thermostatic: total temperature stability

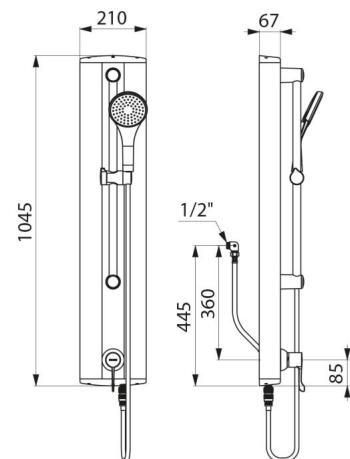

---

Repairability

