

# BIOCLIP mechanical basin mixer

Ref. 2820L

Single hole removable mechanical mixer H.95mm L.120mm, Hygiene lever

## DESCRIPTION





**BIOCLIP mechanical basin mixer - Ref. 2820L**

Deck-mounted mechanical basin mixer.  
 BIOCLIP mechanical mixer: mixer can be removed entirely for cleaning and disinfection.  
 Single hole mixer with spout H. 95mm L. 120mm fitted with a hygienic BIOSAFE nozzle.  
 Spout suitable for fitting a BIOFIL point-of-use filter.  
 Ø 35mm ceramic cartridge with pre-set maximum temperature limiter.  
 Body and spout with smooth interiors and low water volume.  
 No risk of cross flow between the hot and cold water.  
 No non-return valves on the inlets.  
 Flow rate regulated at 5 lpm.  
 Hygiene control lever 150mm.  
 Ergonomic, brass pop-up waste 1 1/4".  
 Supplied with PEX flexibles F3/8" with stopcocks in chrome-plated brass.  
 Fixing reinforced by 2 stainless steel rods.  
 Mechanical mixer ideal for healthcare facilities, retirement and care homes, hospitals and clinics.  
 Single hole mixer suitable for people with reduced mobility.  
 Mixer with 30-year warranty.  
 Also available with copper tails.

## TECHNICAL CHARACTERISTICS





**BIOCLIP mechanical basin mixer - Ref. 2820L**

Connector	F3/8"
Technology	BIOCLIP removable mixer
Drop height	95mm
Spout length	120mm
Flow rate	5 lpm
Temperature limiter	Yes
Finish	Chrome-plated brass

Norms	   
Warranty	



## ADVANTAGES

-  Hygiene: remove for internal cleaning
-  Hygiene: smooth interior reduces bacteria
-  Pre-set maximum temperature limiter
-  Hygiene lever: no manual contact

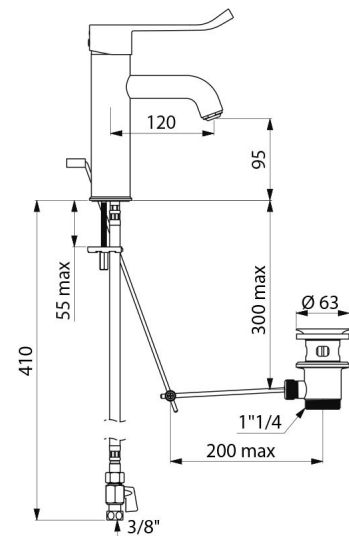

---

Repairability

